

ESI120N21R1L

ev™ Silicon Carbide Power MOSFET
 1200V, 100A, 21mΩ

Features

- High switching speed with a low gate charge
- Very fast diode with low reverse recovery
- Robust Avalanche Capability
- 100% Avalanche Tested
- Easy to Parallel and Simple to Drive
- Pb-free, Halogen Free, and RoHS Compliant

Benefits

- Higher System Efficiency
- Higher Frequency Applicability
- Increased Power Density
- Reduced Cooling Requirements

Applications

- Solar Inverters
- High Voltage DC/DC Converters
- Industrial Power Supply
- EV Charging Station

V _{DSS}	I _D , T _C =25°C	R _{DS(on)} , Typ.	Q _g , Typ.
1200V	100A	21mΩ	198nC

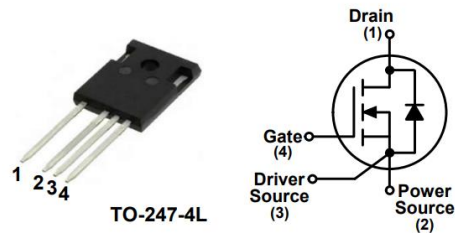

Ordering Information

Part Number	Package	Shipping	Quantity
ESI120N21R1L	TO-247-4L	Tube	30 units

Absolute Maximum Ratings (T_C=25°C, unless otherwise specified)

Symbol	Parameter	Value	Unit	
V _{DSS}	Drain to Source Voltage	1200	V	
V _{GS}	Gate to Source Voltage (DC)	-10/+22		
V _{GSop}	Recommended Operation Values of Gate to Source Voltage	-5/+18		
I _D	Continuous Drain Current	T _C =25°C	100	A
		T _C =100°C	71	
I _{DM}	Pulsed Drain Current (Note1)	T _C =25°C	250	
P _D	Power Dissipation	T _C =25°C	469	W
		T _C =100°C	234	W
T _J , T _{STG}	Operating and Storage Temperature Range	-55 to 175	°C	
T _L	Maximum Lead Temperature for Soldering, 1/8" from Case for 10 Seconds	260	°C	

Note1: Limited by maximum junction temperature.

■ Thermal Characteristics

Symbol	Parameter	Value	Unit
$R_{\theta JC}$	Maximum Thermal Resistance, Junction to Case	0.32	°C/W
$R_{\theta JA}$	Maximum Thermal Resistance, Junction to Ambient	40	

■ Electrical Characteristics ($T_C=25^\circ\text{C}$, unless otherwise specified)

Symbol	Parameter	Test Conditions	Min.	Typ.	Max.	Unit
--------	-----------	-----------------	------	------	------	------

Off Characteristics

V_{DSS}	Drain to Source Breakdown Voltage	$V_{GS}=0V, I_D=1mA$	1200			V
I_{DSS}	Zero Gate Voltage Drain Current	$V_{DS}=1200V, V_{GS}=0V$		1	100	μA
		$V_{DS}=1200V, V_{GS}=0V, T_J=175^\circ\text{C}$		10		
I_{GSS}	Gate-Source Leakage Current	$V_{GS}=+22V, V_{DS}=0V$			+100	nA
		$V_{GS}=-10V, V_{DS}=0V$			-100	

On Characteristics

$V_{GS(th)}$	Gate Threshold Voltage	$V_{GS}=V_{DS}, I_D=17mA$	2.0	3.0	4.5	V
$R_{DS(on)}$	Static Drain to Source On Resistance	$V_{GS}=18V, I_D=50A$		21	29.4	m Ω
		$V_{GS}=18V, I_D=50A, T_J=175^\circ\text{C}$		33.6		
g_{fs}	Transconductance	$V_{DS}=20V, I_D=50A$		24.4		S

Dynamic Characteristics

C_{iss}	Input Capacitance	$V_{DS}=800V, V_{GS}=0V, f=250kHz$		3741		μF
C_{oss}	Output Capacitance			224		
C_{rss}	Reverse Capacitance			17		
E_{oss}	Stored Energy in Output Capacitance	$V_{DS}=0V$ to $800V, V_{GS}=0V$		93		μJ
$Q_{g(tot)}$	Total Gate Charge	$V_{DS}=800V, I_D=50A,$ $V_{GS}=-5V/18V,$ Inductive load		198		nC
Q_{gs}	Gate to Source Charge			48		
Q_{gd}	Gate to Drain "Miller" Charge			65		
R_G	Internal Gate Resistance	$f=1MHz$		3.0		Ω

Switching Characteristics

$t_{d(on)}$	Turn-On Delay Time	$V_{DS}=800V, I_D=50A,$ $V_{GS}=-5V/18V, R_G=2\Omega,$ Inductive load		29		ns
t_r	Turn-On Rise Time			29		
$t_{d(off)}$	Turn-Off Delay Time			62		
t_f	Turn-Off Fall Time			12		
E_{on}	Turn-On Switching Energy			452		μJ
E_{off}	Turn-Off Switching Energy			345		
E_{tot}	Total Switching Energy			797		

■ Reverse Diode Characteristics ($T_C=25^\circ\text{C}$, unless otherwise specified)

Symbol	Parameter	Test Conditions	Min.	Typ.	Max.	Unit
I_S	Continuous Diode Forward Current	$V_{GS}=-5V$			100	A
I_{SM}	Pulsed Diode Forward Current	$V_{GS}=-5V$			250	
V_{SD}	Diode Forward Voltage	$V_{GS}=-5V, I_{SD}=50A$		4.2		V
		$V_{GS}=-5V, I_{SD}=50A, T_J=175^\circ\text{C}$		3.7		
t_{rr}	Reverse Recovery Time	$V_{DD}=800V, I_{SD}=50A, V_{GS}=-5V, dI_S/dt=1000A/\mu s$		76		ns
Q_{rr}	Reverse Recovery Charge			530		nC
E_{rec}	Reverse Recovery Energy			26		μJ
I_{rrm}	Peak Reverse Recovery Current			24		A

■ **Typical Characteristics** ($T_J=25^\circ\text{C}$ unless otherwise noted)

Figure 1. On-Region Characteristics $T_J=-40^\circ\text{C}$

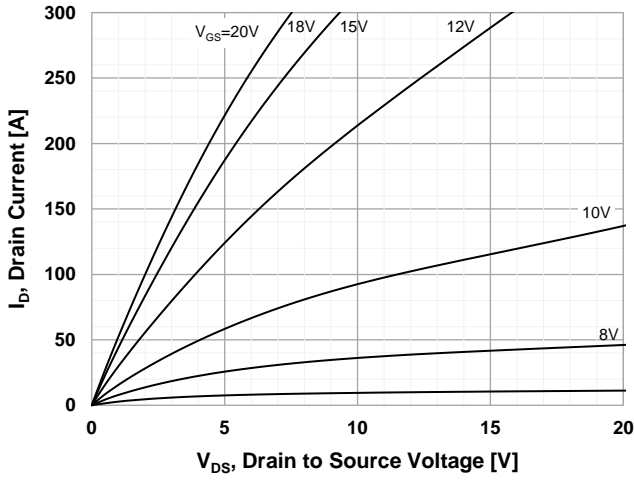

Figure 2. On-Region Characteristics $T_J=25^\circ\text{C}$

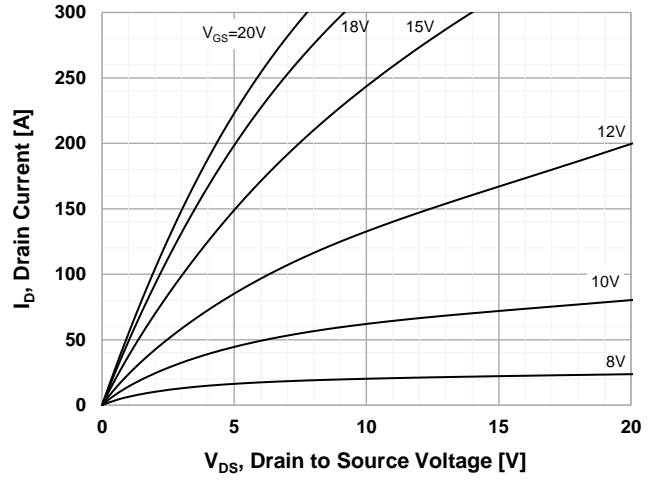

Figure 3. On-Region Characteristics $T_J=175^\circ\text{C}$

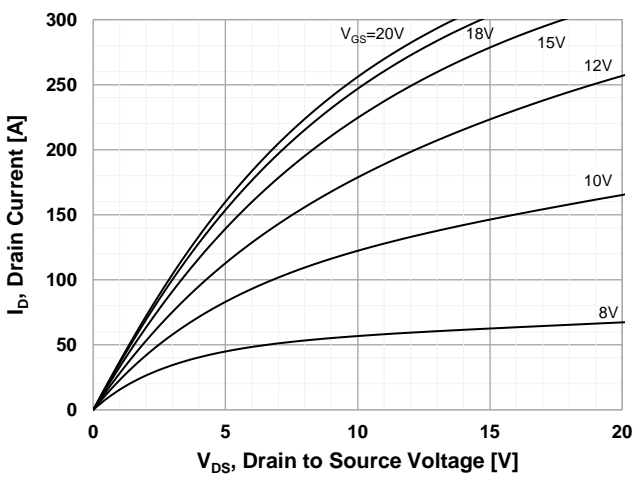

Figure 4. Normalized On-Region Characteristics vs. Temperature

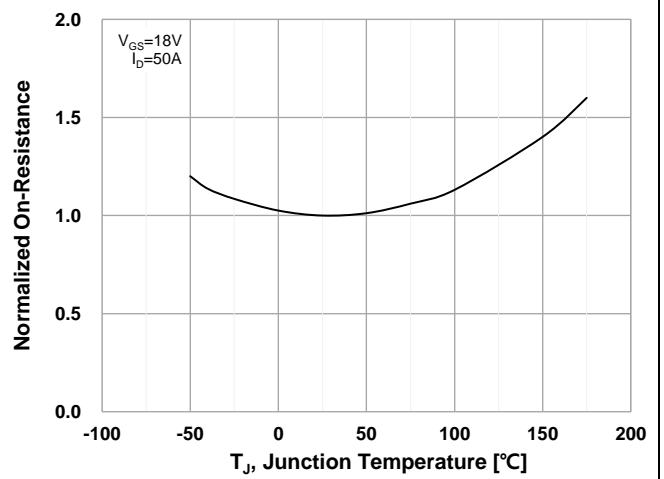

Figure 5. Transfer Characteristics

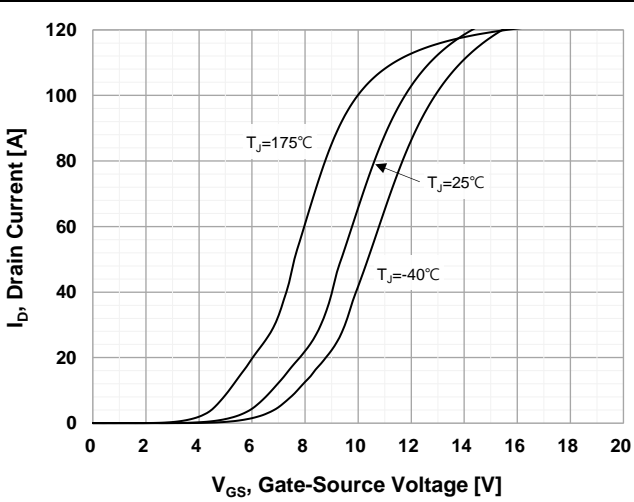
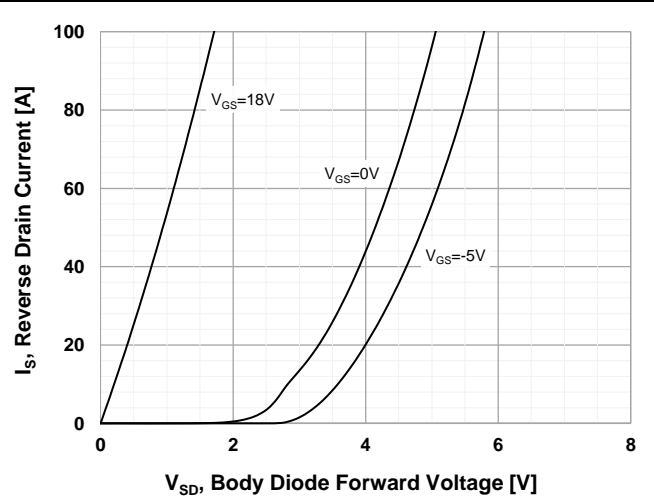

Figure 6. Diode Forward Voltage Characteristics vs. Source-Drain Current $T_J=-40^\circ\text{C}$



■ Typical Characteristics

Figure 7. Diode Forward Voltage Characteristics vs. Source-Drain Current $T_J=25^\circ\text{C}$

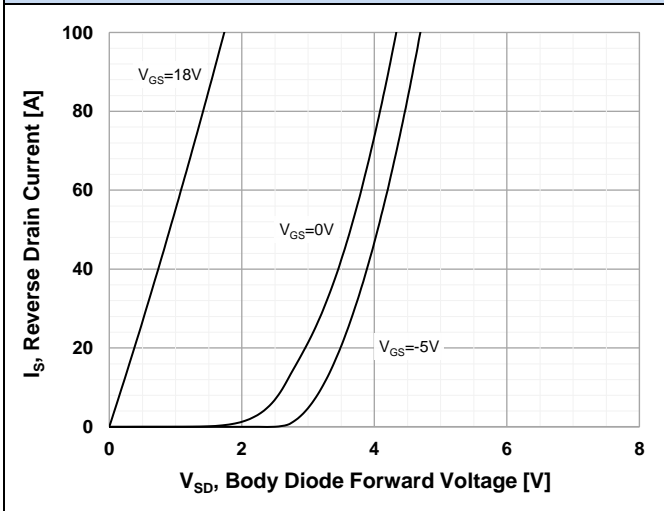

Figure 8. Diode Forward Voltage Characteristics vs. Source-Drain Current $T_J=175^\circ\text{C}$

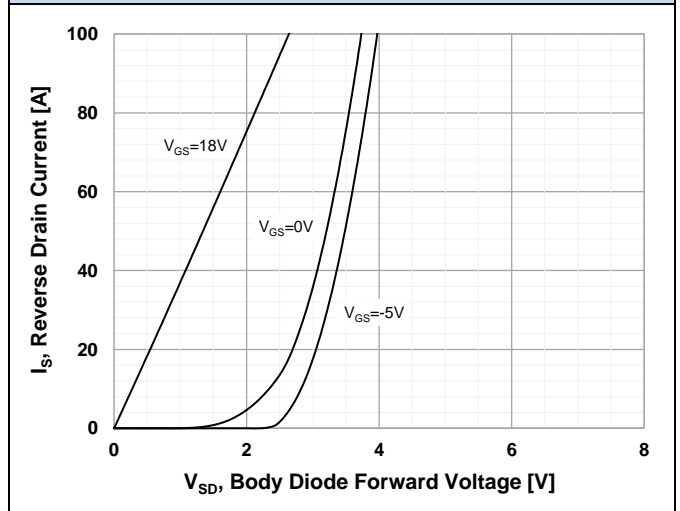

Figure 9. Threshold Voltage vs. Temperature

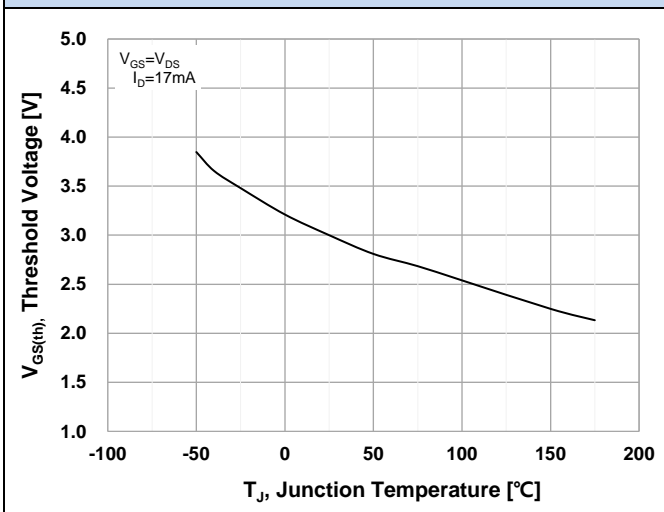

Figure 10. Gate Charge Characteristics

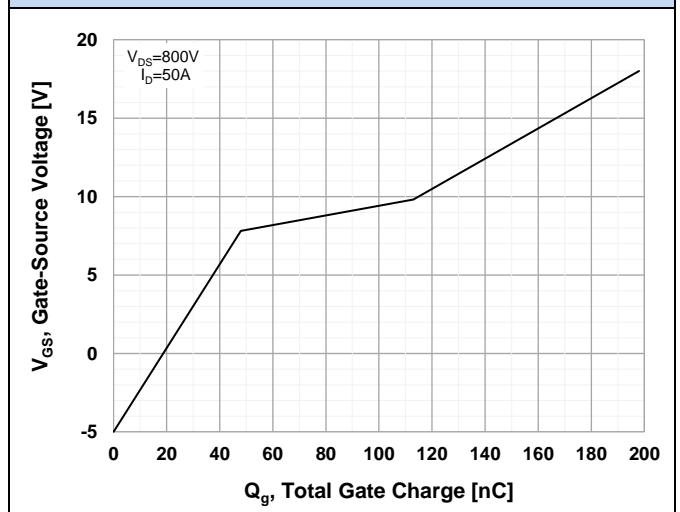

Figure 11. Stored Energy in Output Capacitance

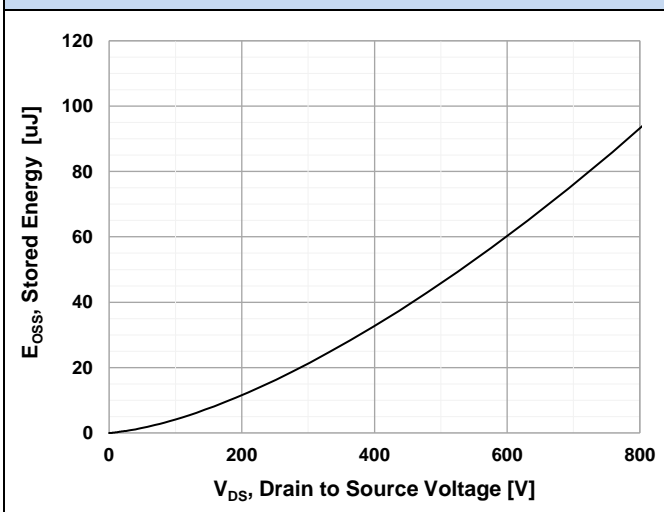
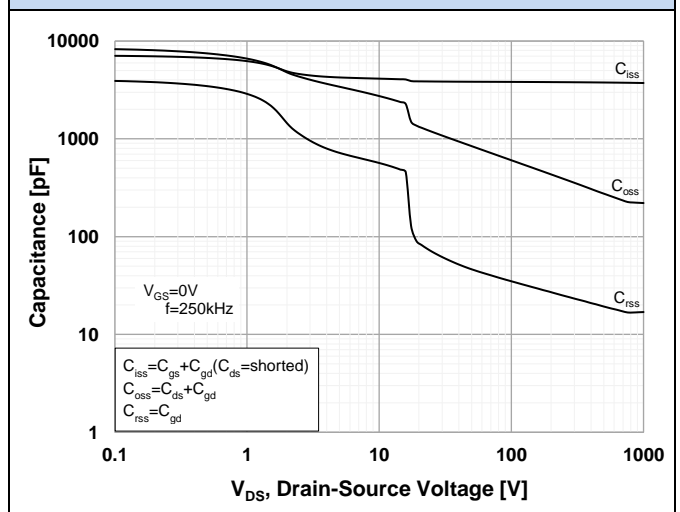

Figure 12. Capacitance Characteristics



■ Typical Characteristics

Figure 13. Continuous Drain Current Derating vs. Case Temperature

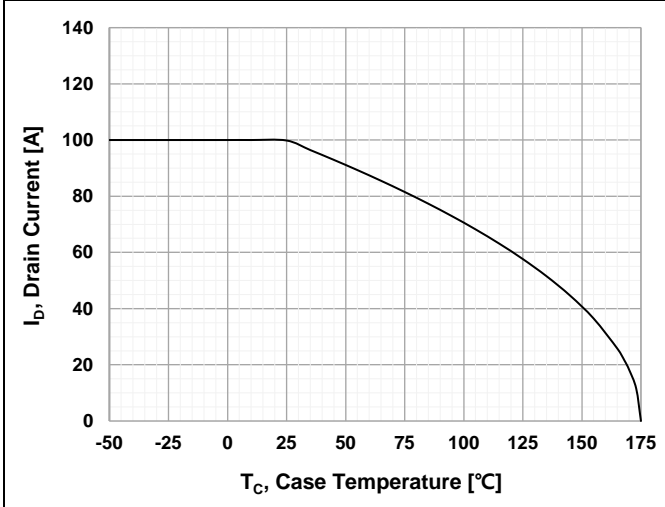

Figure 14. Maximum Power Dissipation Derating vs. Case Temperature

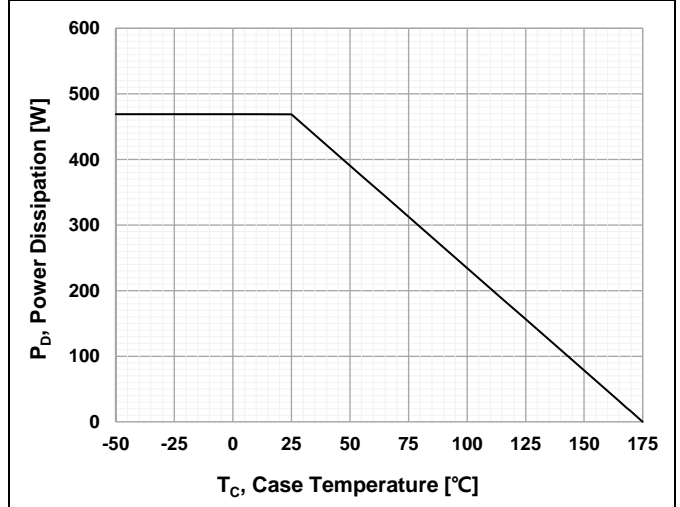

Figure 15. Typ. Switching Loss vs. Drian Current

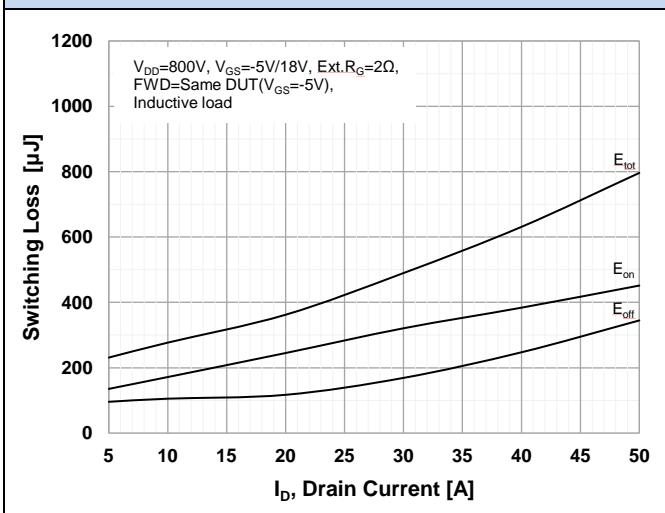

Figure 16. Typ. Switching Loss vs. Gate Resistance

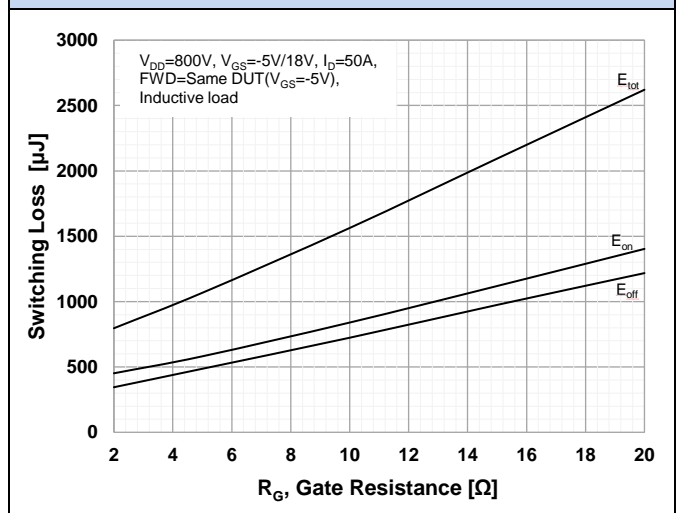

Figure 17. Maximum Safe Operating Area

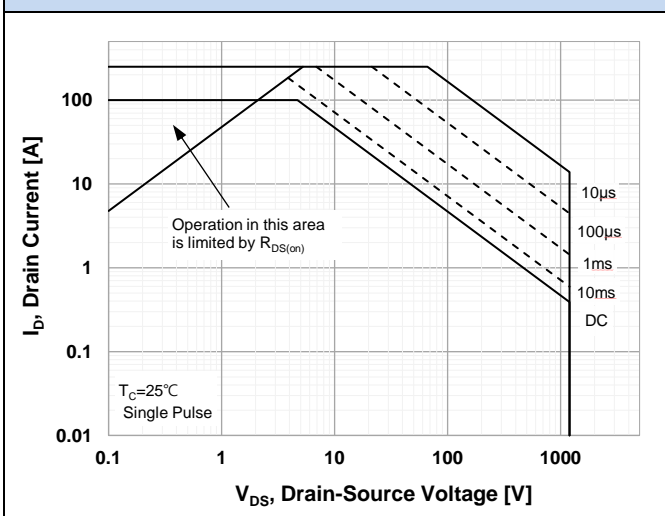
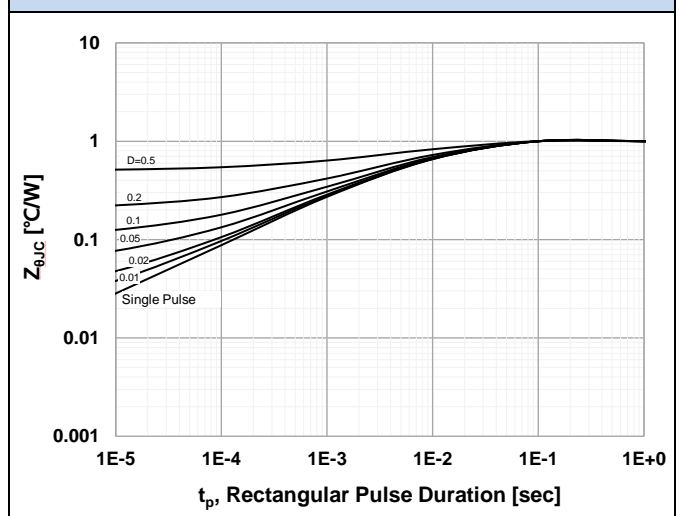

Figure 18. Transient Thermal Response Curve



■ Test Conditions

Figure 19. Inductive Load Switching Test Circuit and Waveforms

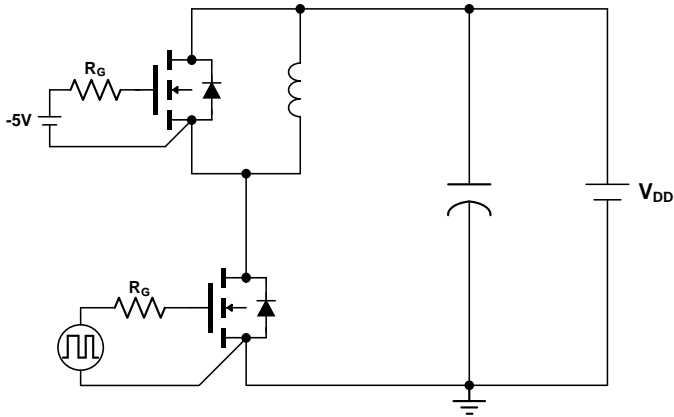

Figure A. Inductive Switching Test Circuit

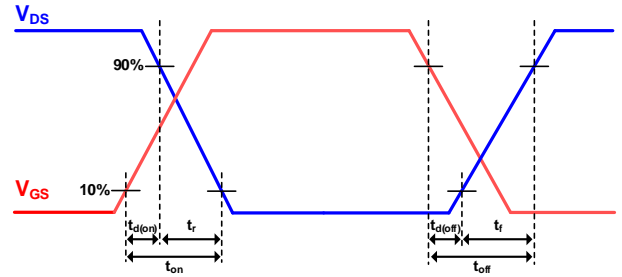

Figure B. Inductive Switching Waveforms

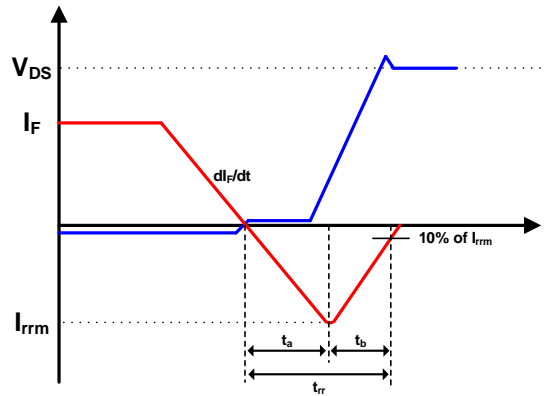
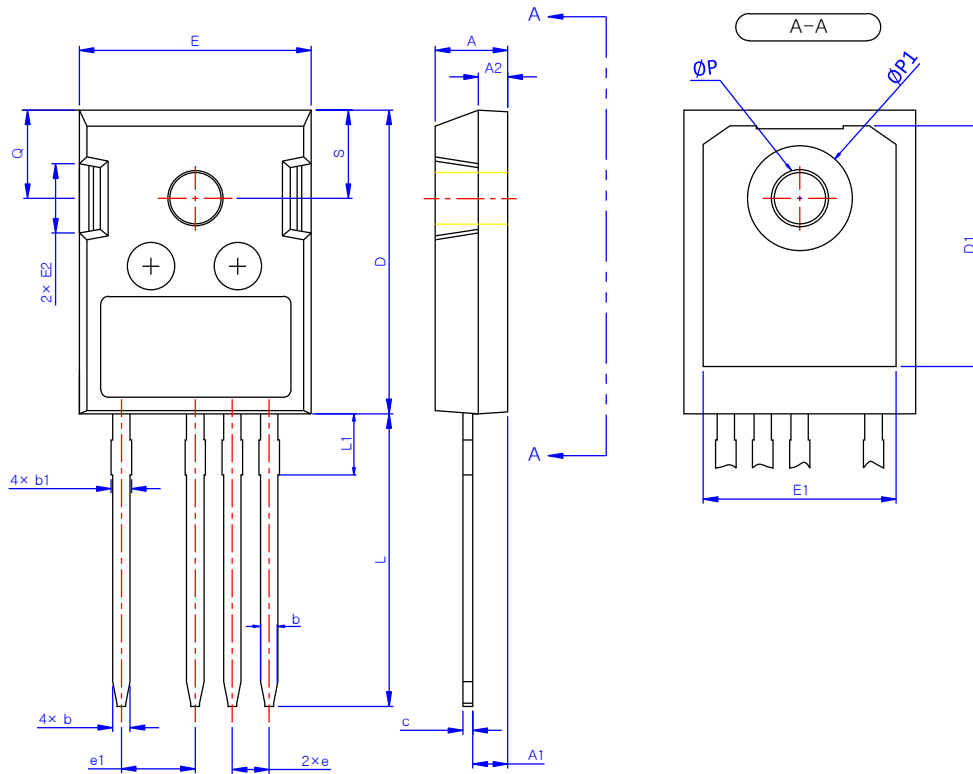

Figure C. Diode Switching Waveforms

Package Outlines TO-247-4L



SYMBOL	MIN	MAX
A	4.80	5.20
A1	2.29	2.54
A2	1.90	2.10
b	1.10	1.30
b1	1.30	1.50
c	0.50	0.70
D	20.80	21.34
D1	17.43	17.83
E	15.75	16.13
E1	13.06	13.46
E2	4.32	4.83
e	2.54 BSC	
e1	5.08 BSC	
L	19.85	20.25
L1	-	4.49
$\varnothing P$	3.55	3.65
$\varnothing P1$	7.00	7.40
Q	5.59	6.19
S	6.15 BSC	

*Dimensions in millimeters

Important Notice

Elevation reserves the right to modify, improve, and terminate its products, services, documentations, etc. without advance notice. Customers are encouraged to contact Elevation sales representatives to get the latest product information.

Without proper legal authorization, Elevation products shall not be used for medical or military applications. Elevation does not assume any liability of personal or property damages of any kind due to such applications.

All text, images, trademarks of this document, and any intellectual property contained in the product and in this document belong to Elevation. No part of this document may be used, copied, modified, distributed, or published without legal authorization from Elevation.

© 2022 Elevation Microsystems. All rights reserved. www.elevationmicro.com