

EDH120D40R1V

ev™ Automotive Grade Silicon Carbide Schottky Diode 1200V, 40A

Features

- Zero Reverse Recovery Current
- Low Forward Voltage
- High Surge Current Capability
- Independent of Temperature Switching Behavior
- Positive Temperature Coefficient
- Max Junction Temperature 175 °C
- Pb-free, Halogen Free, and RoHS Compliant
- Qualified to AEC-Q101

V_{RRM}	$I_F, T_C=25^\circ C$	$T_{J, Max}$	Q_C, Typ
1200V	20 / 40A	175°C	120nC

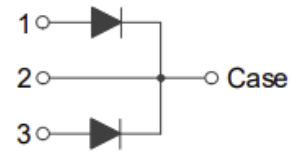
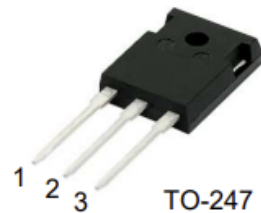

Benefits

- Higher Efficiency
- Ease of Paralleling
- Increased Power Density
- Reduced Cooling Requirements



Applications

- On-board Charger / PFC
- DC-DC Converter
- Auxiliary Inverter

Ordering Information

Part Number	Package	Shipping	Quantity
EDH120D40R1V	TO-247-3L	Tube	30 units

■ Absolute Maximum Ratings (Per Leg / $T_C=25^\circ C$, unless otherwise specified)

Symbol	Parameter	Value	Unit
V_{RRM}	Repetitive Peak Reverse Voltage	1200	V
I_F	Forward Current (Per leg / Device)	$T_C=147^\circ C$ 20 / 40	A
$I_{F,SM}$	Non-Repetitive Forward Surge Current (Per leg)	$T_C=25^\circ C, t_p=10ms$	135
		$T_C=150^\circ C, t_p=10ms$	115
$I_{F,Max}$	Non-Repetitive Peak Forward Current (Per leg)	$T_C=25^\circ C, t_p=10\mu s$	1180
		$T_C=150^\circ C, t_p=10\mu s$	980
I^2dt value	$\int I^2t$ (Per leg)	$T_C=25^\circ C, t_p=10ms$	91
		$T_C=150^\circ C, t_p=10ms$	66
P_{tot}	Power Dissipation (Per leg)	$T_C=25^\circ C$ 217	W
T_J, T_{STG}	Operating and Storage Temperature Range	-55 to 175	°C

■ Thermal Characteristics

Symbol	Parameter	Value	Unit
$R_{\theta JC}$	Maximum Thermal Resistance, Junction to Case (Per leg / Device)	0.69 / 0.35	°C/W

■ Electrical Characteristics (Per Leg / $T_C=25^\circ\text{C}$, unless otherwise specified)

Symbol	Parameter	Test Conditions	Min.	Typ.	Max.	Unit
V_F	Forward Voltage (Per leg)	$I_F=20\text{A}$, $T_J=25^\circ\text{C}$		1.39	1.70	V
		$I_F=20\text{A}$, $T_J=175^\circ\text{C}$		1.80		
I_R	Reverse Current (Per leg)	$V_R=1200\text{V}$, $T_J=25^\circ\text{C}$			100	μA
		$V_R=1200\text{V}$, $T_J=175^\circ\text{C}$			300	
Q_C	Total Capacitive Charge (Per leg)	$V_R=800\text{V}$, $T_J=25^\circ\text{C}$		120		nC
C	Total Capacitance (Per leg)	$V_R=1\text{V}$, $f=100\text{kHz}$		1357		pF
		$V_R=800\text{V}$, $f=100\text{kHz}$		85		
E_C	Capacitance Stored Energy (Per leg)	$V_R=800\text{V}$		34		μJ

■ **Typical Characteristics** (Per Lag / $T_J=25^\circ\text{C}$ unless otherwise noted)

Figure 1. Forward Characteristics

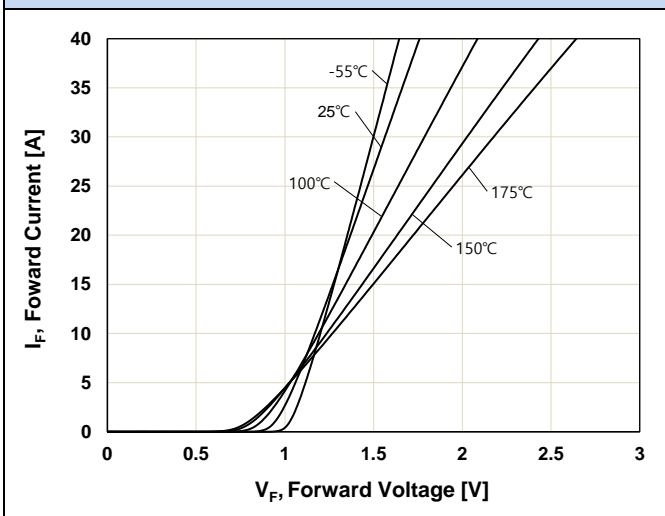

Figure 2. Reverse Characteristics

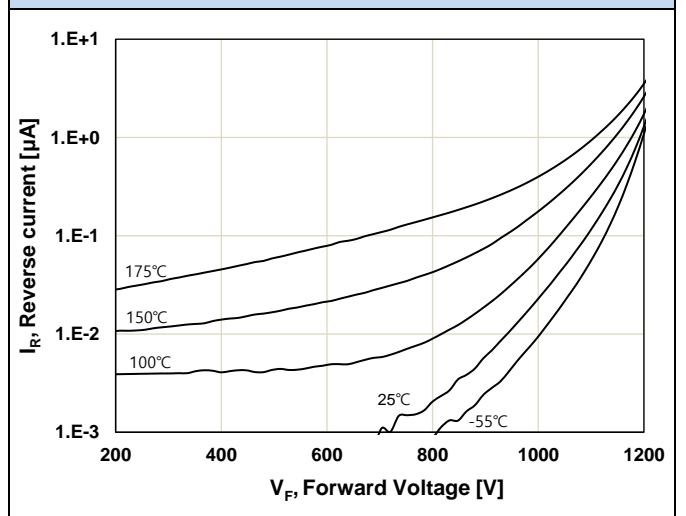

Figure 3. Power Derating

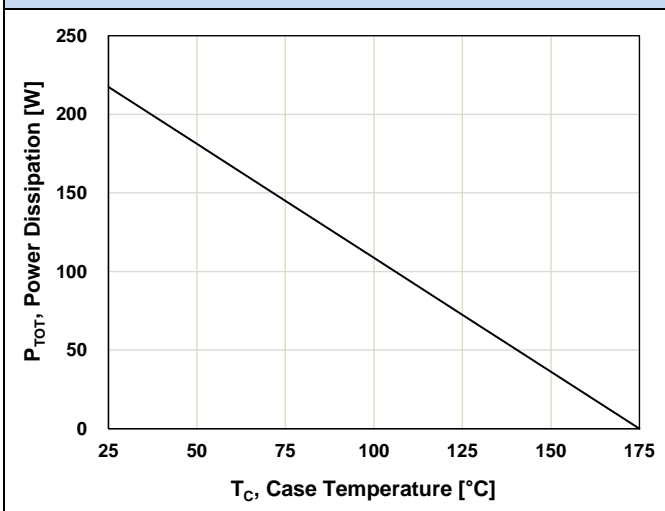

Figure 4. Current Derating

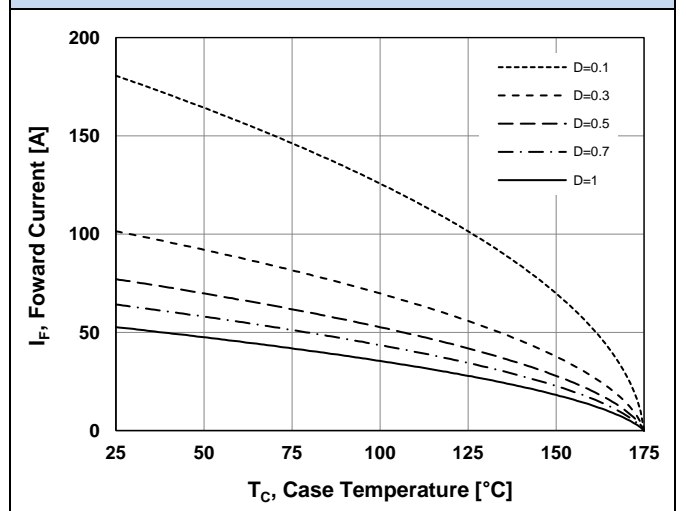

Figure 5. Capacitive Charge Characteristics

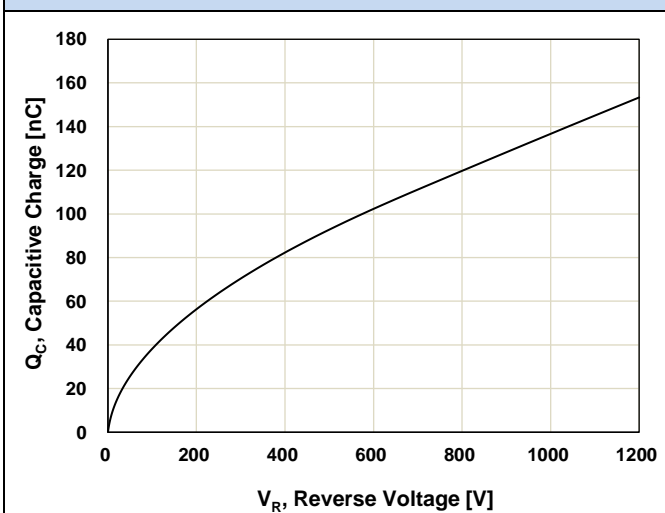
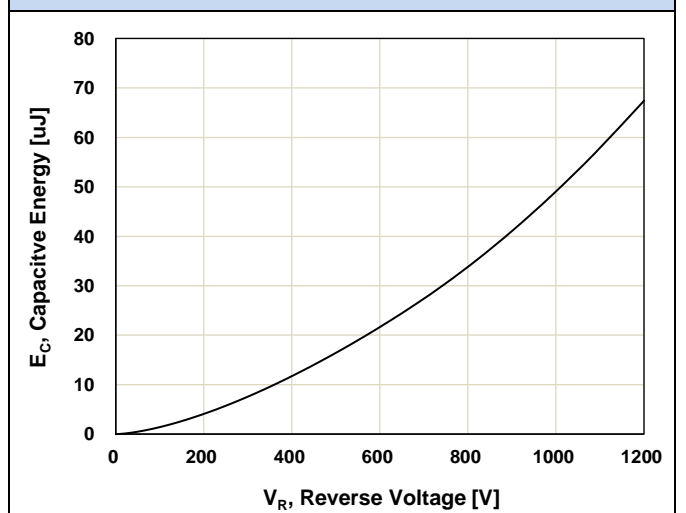
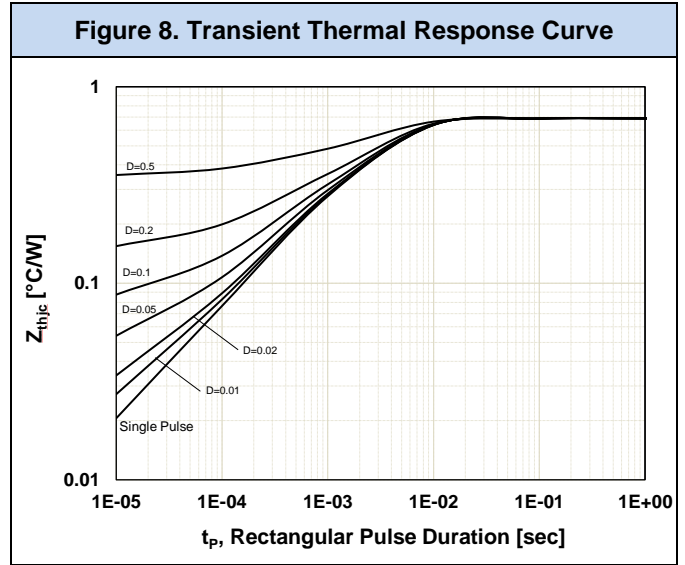
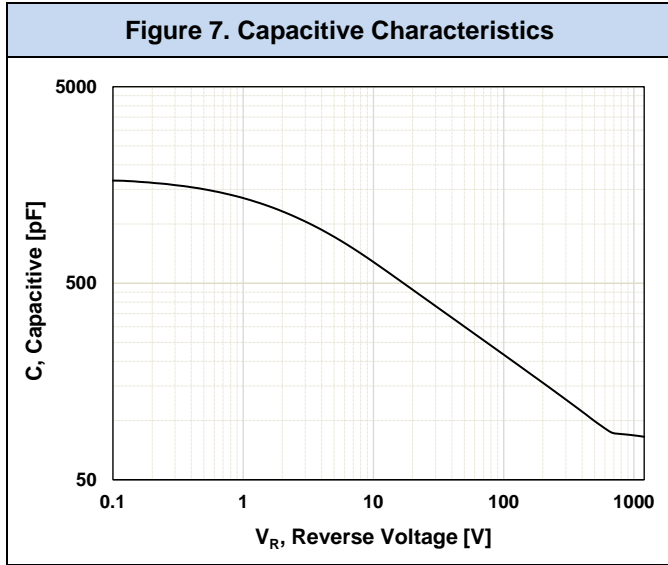

Figure 6. Capacitance Stored Energy



■ Typical Characteristics (Per Lag)



Package Outlines TO-247-3L

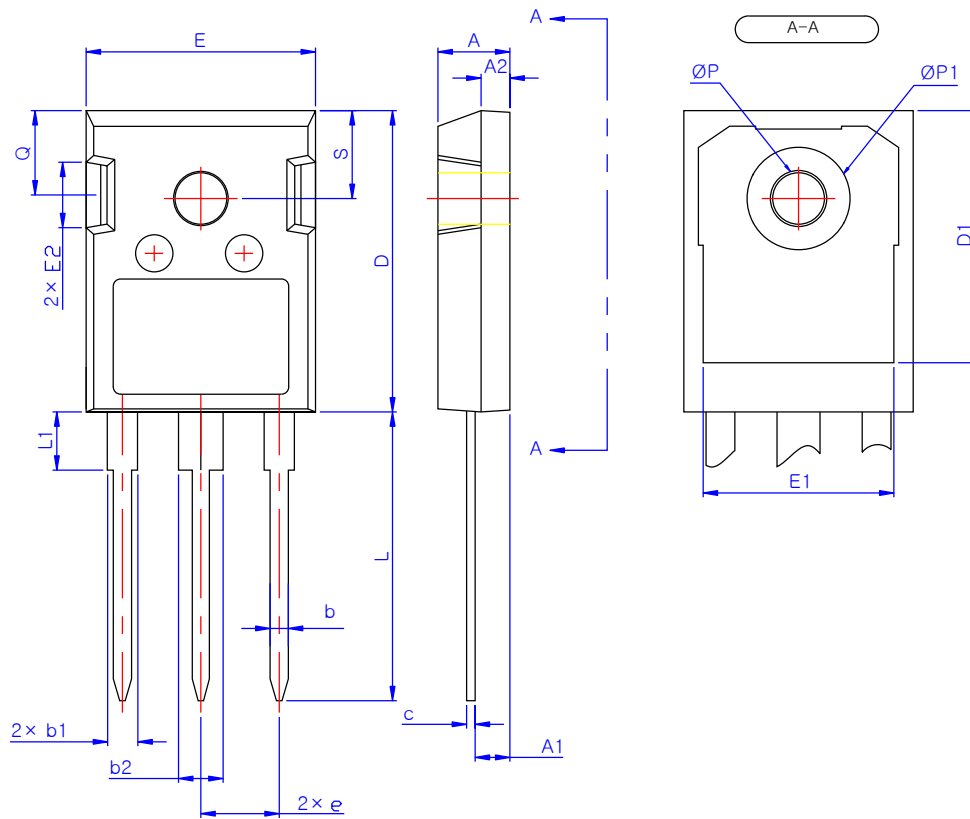

SYMBOL	MIN	MAX
A	4.80	5.20
A1	2.29	2.54
A2	1.90	2.10
b	1.10	1.30
b1	1.91	2.20
b2	2.92	3.20
c	0.50	0.70
D	20.80	21.34
D1	17.43	17.83
E	15.75	16.13
E1	13.06	13.46
E2	4.32	4.83
e	5.45 BSC	
L	19.85	20.25
L1	-	4.49
ØP	3.55	3.65
ØP1	7.08	7.28
Q	5.59	6.19
S	6.15 BSC	

*Dimensions in millimeters

Important Notice

Elevation reserves the right to modify, improve, and terminate its products, services, documentations, etc. without advance notice. Customers are encouraged to contact Elevation sales representatives to get the latest product information.

Without proper legal authorization, Elevation products shall not be used for medical or military applications. Elevation does not assume any liability of personal or property damages of any kind due to such applications.

All text, images, trademarks of this document, and any intellectual property contained in the product and in this document belong to Elevation. No part of this document may be used, copied, modified, distributed, or published without legal authorization from Elevation.

© 2022 Elevation Microsystems. All rights reserved. www.elevationmicro.com