

EDF65S20R1L

ev™ Silicon Carbide Schottky Diode 650V, 20A

Features

- Zero Reverse Recovery Current
- Low Forward Voltage
- High Surge Current Capability
- Independent of Temperature Switching Behavior
- Positive Temperature Coefficient
- Max Junction Temperature 175 °C
- Pb-free, Halogen Free, and RoHS Compliant

V_{RRM}	$I_F, T_C=25^\circ C$	$T_{J, Max}$	Q_C, Typ
650V	20A	175°C	60nC

Benefits

- Higher Efficiency
- Ease of Paralleling
- Increased Power Density
- Reduced Cooling Requirements



Applications

- Solar Inverters
- Power Factor Correction
- Industrial Power Supply
- EV Charging Station



Ordering Information

Part Number	Package	Shipping	Quantity
EDF65S20R1L	TO-220F-2L	Tube	50 units

Absolute Maximum Ratings ($T_C=25^\circ C$, unless otherwise specified)

Symbol	Parameter		Value	Unit
V_{RRM}	Repetitive Peak Reverse Voltage		650	V
I_F	Forward Current	$T_C=40^\circ C$	20	A
$I_{F, SM}$	Non-Repetitive Forward Surge Current	$T_C=25^\circ C, t_p=10ms$	95	A
		$T_C=150^\circ C, t_p=10ms$	81	
$I_{F, Max}$	Non-Repetitive Peak Forward Current	$T_C=25^\circ C, t_p=10\mu s$	880	A
		$T_C=150^\circ C, t_p=10\mu s$	750	
I^2dt value	$\int I^2 dt$	$T_C=25^\circ C, t_p=10ms$	45.1	A^2s
		$T_C=150^\circ C, t_p=10ms$	32.7	A^2s
P_{tot}	Power Dissipation	$T_C=25^\circ C$	43	W
T_J, T_{STG}	Operating and Storage Temperature Range		-55 to 175	°C

■ Thermal Characteristics

Symbol	Parameter	Value	Unit
$R_{\theta JC}$	Maximum Thermal Resistance, Junction to Case	3.5	°C/W

■ Electrical Characteristics (T_C=25°C, unless otherwise specified)

Symbol	Parameter	Test Conditions	Min.	Typ.	Max.	Unit
V_F	Forward Voltage	$I_F=20A, T_J=25^\circ C$		1.40	1.70	V
		$I_F=20A, T_J=175^\circ C$		1.55		
I_R	Reverse Current	$V_R=650V, T_J=25^\circ C$			100	μA
		$V_R=650V, T_J=175^\circ C$			300	
Q_C	Total Capacitive Charge	$V_R=400V, T_J=25^\circ C$		60		nC
C	Total Capacitance	$V_R=1V, f=100kHz$		981		pF
		$V_R=400V, f=100kHz$		95		
E_C	Capacitance Stored Energy	$V_R=400V$		8.9		μJ

■ **Typical Characteristics** ($T_J=25^\circ\text{C}$ unless otherwise noted)

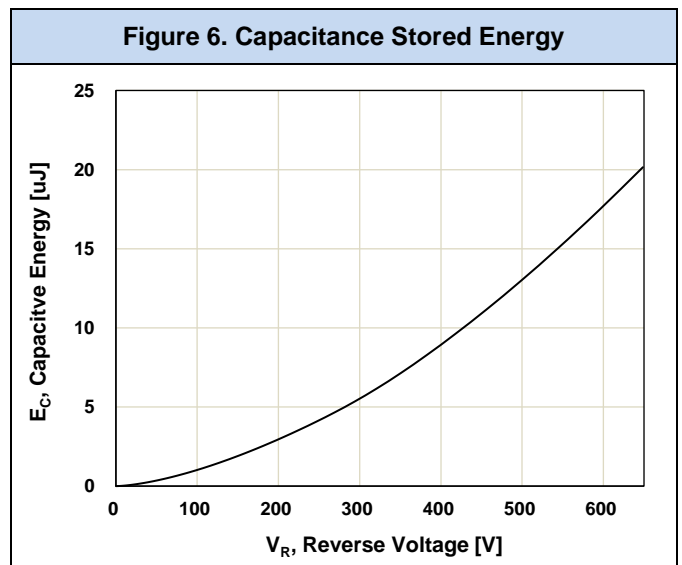
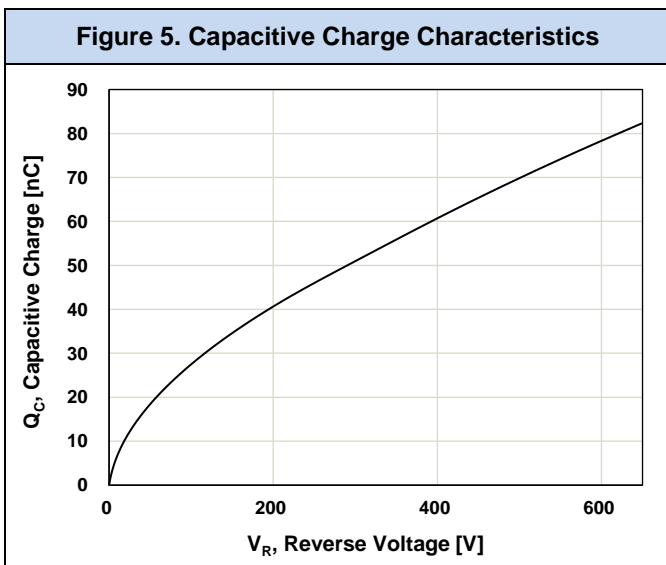
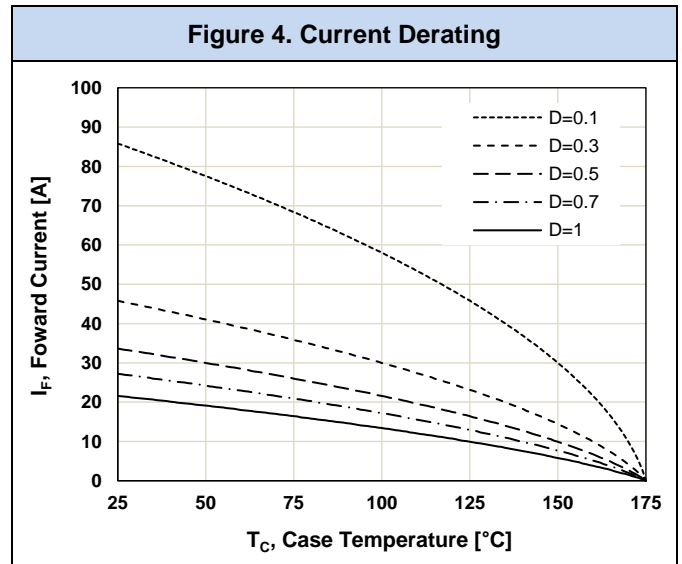
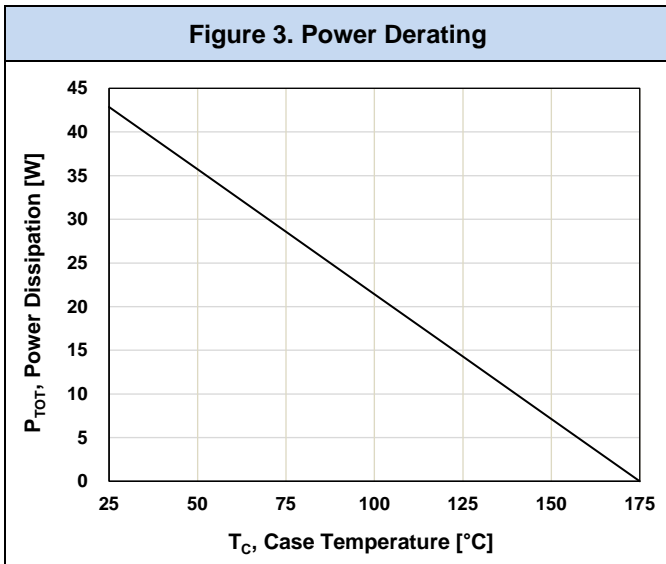
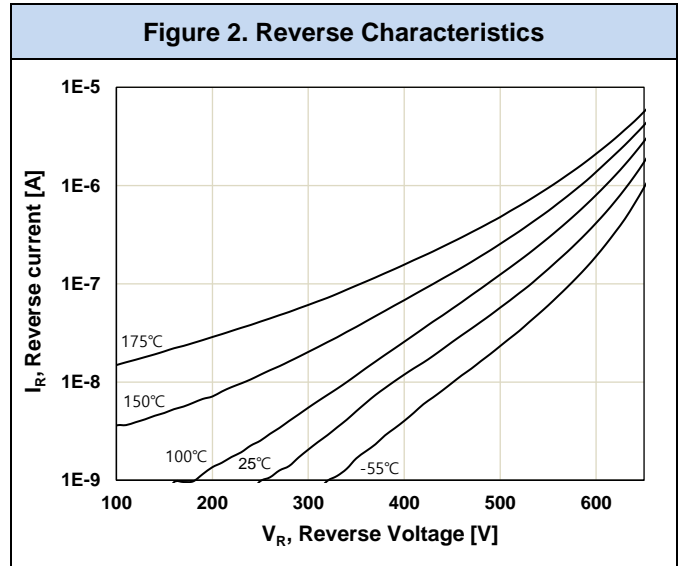
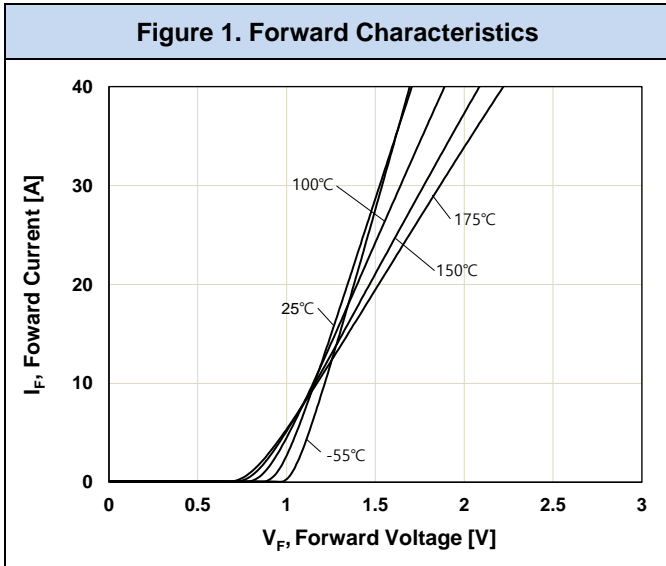

■ Typical Characteristics

Figure 7. Capacitive Characteristics

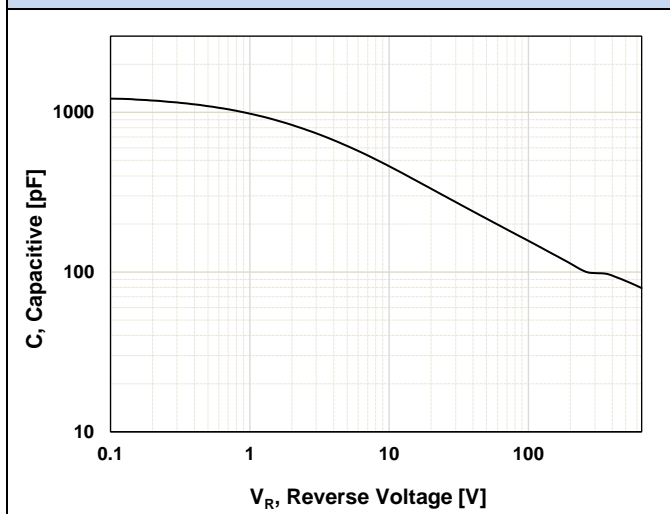
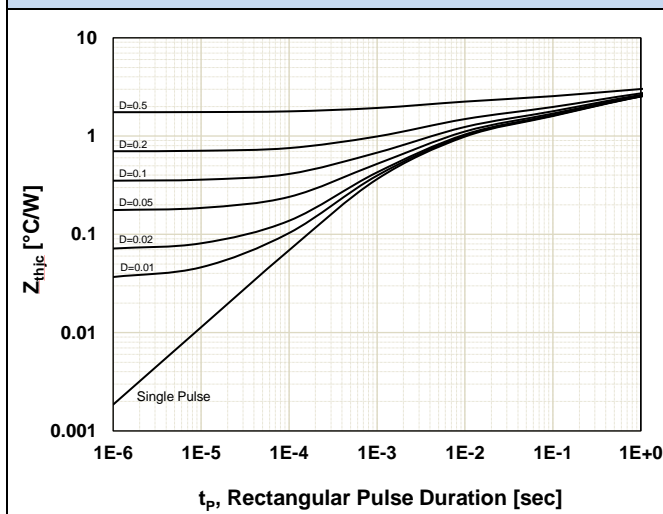
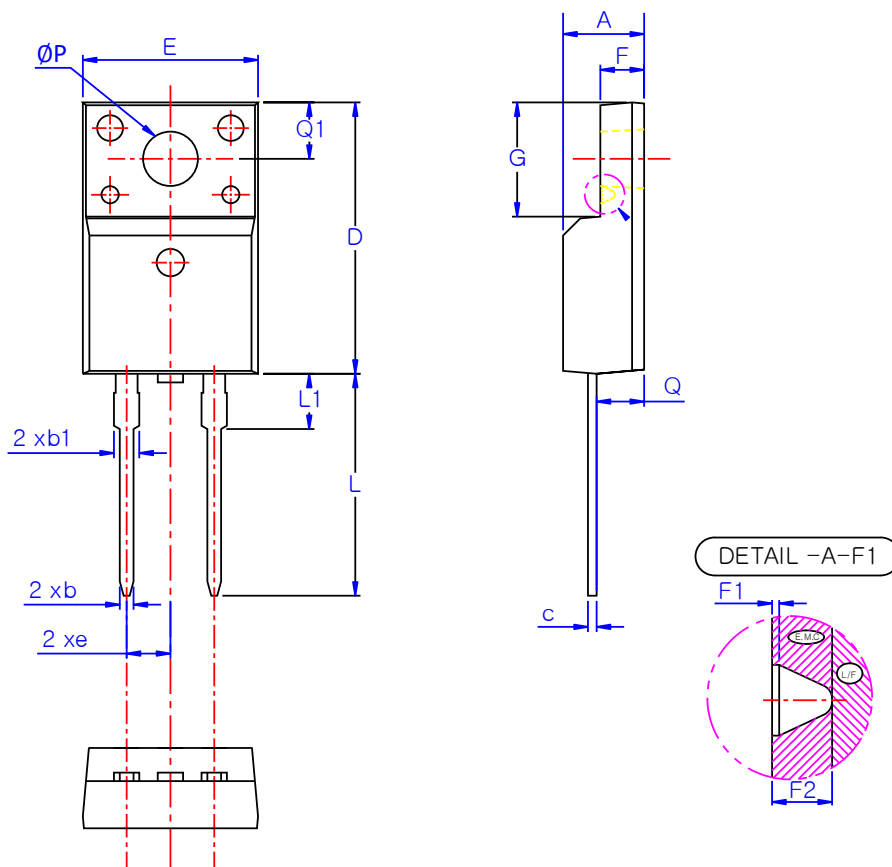

Figure 8. Transient Thermal Response Curve



Package Outlines TO-220F-2L



SYMBOL	MIN	NOM	MAX
A	4.50	4.70	4.90
b	0.70	0.80	0.90
b1	1.33	1.40	1.47
c	0.45	0.50	0.60
D	15.67	15.87	16.07
E	9.96	10.16	10.36
e	2.54 BSC		
F	2.34	2.54	2.74
	(0.10)		
F2	(0.84)		
G	6.48	6.68	6.88
L	12.78	12.98	13.18
L1	3.03	3.23	3.43
Q	2.56	2.76	2.96
Q1	3.10	3.30	3.50
ØP	3.08	3.18	3.28

NOTE

1. THESE DIMENSIONS DO NOT INCLUDE PROTRUSIONS OF THE MOLD.
2. THE "()" MARK IS THE REFERENCE.

Important Notice

Elevation reserves the right to modify, improve, and terminate its products, services, documentations, etc. without advance notice. Customers are encouraged to contact Elevation sales representatives to get the latest product information.

Without proper legal authorization, Elevation products shall not be used for medical or military applications. Elevation does not assume any liability of personal or property damages of any kind due to such applications.

All text, images, trademarks of this document, and any intellectual property contained in the product and in this document belong to Elevation. No part of this document may be used, copied, modified, distributed, or published without legal authorization from Elevation.

© 2022 Elevation Microsystems. All rights reserved. www.elevationmicro.com